

5 YEARS WARRANTY

IP 67

CE

UK CA

RoHS Compliant

RoHS Compliant

CHALLENGER-0 12VDC | 24VDC INSTALLATION GUIDE

READ THE INSTRUCTIONS CAREFULLY BEFORE MOUNTING

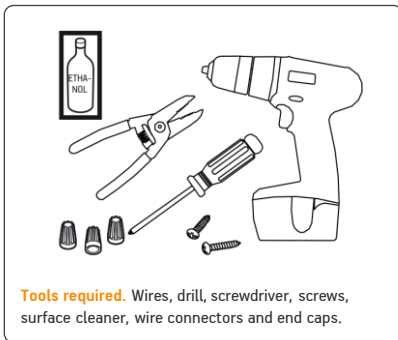

Tools required. Wires, drill, screwdriver, screws, surface cleaner, wire connectors and end caps.

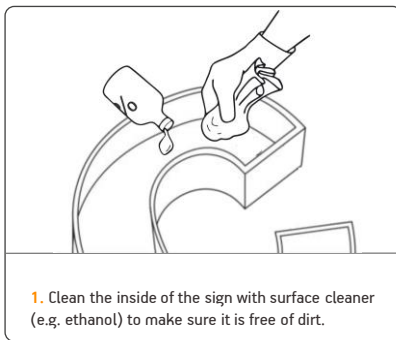

1. Clean the inside of the sign with surface cleaner (e.g. ethanol) to make sure it is free of dirt.

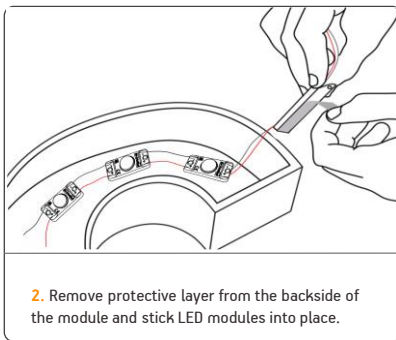

2. Remove protective layer from the backside of the module and stick LED modules into place.

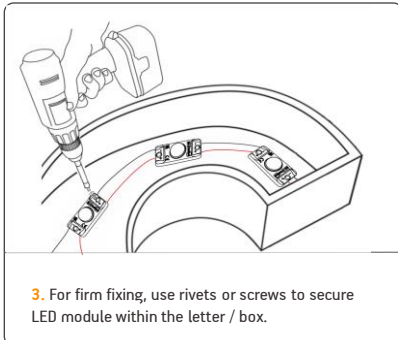

3. For firm fixing, use rivets or screws to secure LED module within the letter / box.

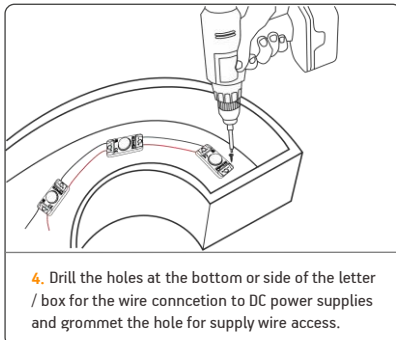

4. Drill the holes at the bottom or side of the letter / box for the wire connection to DC power supplies and grommet the hole for supply wire access.

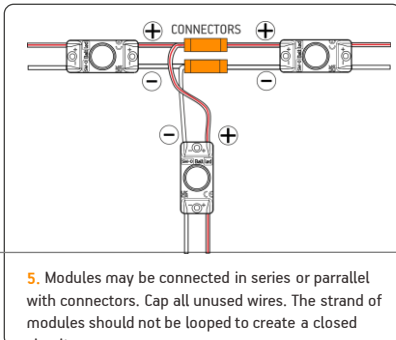

5. Modules may be connected in series or parallel with connectors. Cap all unused wires. The strand of modules should not be looped to create a closed circuit.

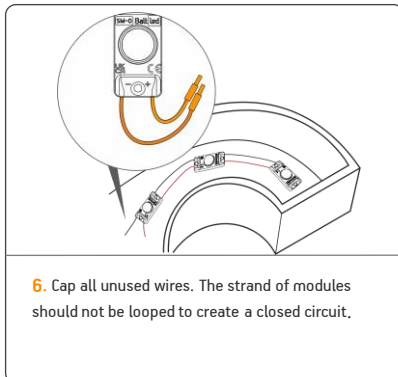

6. Cap all unused wires. The strand of modules should not be looped to create a closed circuit.

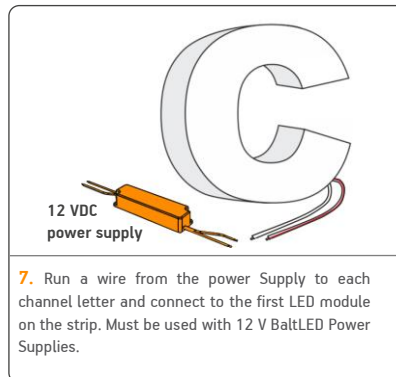

12 VDC power supply

7. Run a wire from the power supply to each channel letter and connect to the first LED module on the strip. Must be used with 12 V BaltLED Power Supplies.

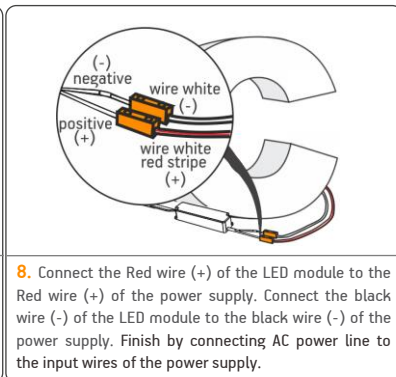

8. Connect the Red wire (+) of the LED module to the Red wire (+) of the power supply. Connect the black wire (-) of the LED module to the black wire (-) of the power supply. Finish by connecting AC power line to the input wires of the power supply.

CONNECTION SCHEME

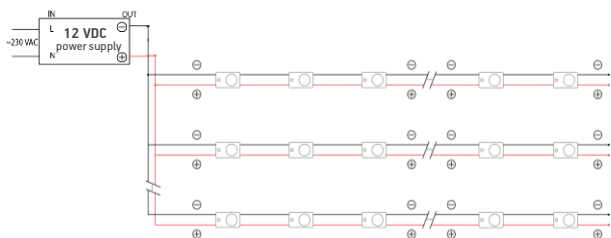

! 30 pcs - max number of modules in one chain when the power supplied from single end.
! String end voltage can't be less than 11V, do not exceed specified module string length

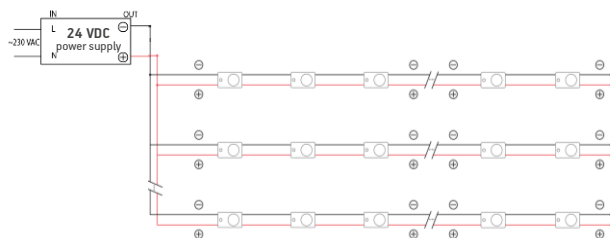

! 80 pcs - max number of modules in one chain when the power supplied from single end.
! String end voltage can't be less than 23V, do not exceed specified module string length

POWER SUPPLY LOAD RECOMMENDATIONS

12 VDC POWER SUPPLY	QUANTITY	2 m*		5 m*		10 m*	
	modules	mm ²	AWG	mm ²	AWG	mm ²	AWG
BPSP-40-12V.1	91	1.3	16	2.5	13	6	10
BPSP-60-12V.1	137	1.5	15	4	11	10	7
BPSP-100-12V.1	228	2	14	6	10	10	7
BPSP-150-12V.1	342	3.3	13	10	7	16	5

24 VDC POWER SUPPLY	QUANTITY	2 m*		5 m*		10 m*	
	modules	mm ²	AWG	mm ²	AWG	mm ²	AWG
BPSP-40-24V.1	160	0.5	20	1.5	15	4	11
BPSP-60-24V.1	240	0.7	18	2	14	4	11
BPSP-100-24V.1	400	1	17	4	11	6	9

© 2024, All rights reserved BaltLED, UAB. Specifications are subject to change without notice.

5 YEARS WARRANTY

IP 67

CE

UK CA

RoHS Compliant

RoHS Compliant

CHALLENGER-0 12VDC | 24VDC INSTALLATION GUIDE

MOUNTING AND USING RECOMENDATIONS

- Be careful not to go beyond recommended maximum quantities of modules for a power supply. Overload may cause blinking or a failure.
- For mounting only pan head tapping screws must be used. The screws must apply DIN 7049 or DIN 968 standards.
- These modules are designed to work with constant-voltage power supply. Use only recommended power supplies, do not connect to a constant-current power supplies as it will cause immediate failure of modules.
- Before installing make sure, that the fixing area can bear the total weight of the modules.
- Please install LED modules with appropriate cables. There is a possibility, that cables may get disconnected due to contractions, caused by temperature changes.
- Please check that sulphur constituent is not contained in used components when the module is installed.
- Make sure to install modules in a place with a sufficient breathability in order to prevent lifetime reduction by heat. Operating temperature should not exceed +50 °C.
- When installing a module in a fixture (signboard), make sure to provide ventilation for constituent sulphur, drainage for rain water to prevent aged deteriorations.
- When fixing cables of the modules do not use metal cable stop. The tunic of the cable may be damaged and therefore lead to short-circuited.
- Be sure to install modules at a maintainable place.
- In order to prevent LED from breaking down caused by static electricity, make sure not to touch the metal parts of the cable directly with bare hands.
- Make sure to apply correct polarity and direction of the modules. If mistaken, it will lead to failure and break down of the modules.
- When trying to perform lighting test (burn-in test), be sure to connect module to a power supply. Modules can fail to light up due to over-current. If the power supply is turned on without LED modules connected, modules can be connected only 5 minutes after the power supply has been turned off. Residual electricity may cause damage to modules.
- Avoid applying force while bending, twisting or pulling the power supply cables to minimize the risk of electrical shock.
- If any signs of smoke or the smell of burning plastic occurs, turn off modules immediately and investigate the power supply and the wiring carefully.
- Make sure to record and keep product lot and installation date of the modules.

STORAGE AND MAINTANANCE CONDITIONS

- Before the maintenance, turn off the power and maintain the modules after modules cool down. Otherwise, electric shock or burn may occur.
- Do not pull the wiring while removing the modules to prevent possible disconnections.
- Make sure to store modules at dry places, avoid elevated temperatures, high pressures, vibrations, corrosive or combustive gas, direct sunlight.
- Do not wipe or spray modules with volatile materials, such as thinner or benzene as it may lead to combustion and malfunctioning.
- Modules cannot operate at presence of materials containing sulphur components or where sulphur containing gas is generated as it leads to changes in light color and malfunctioning.

GENERAL CONDITIONS

- Installation of modules must carried out by a qualified technician according to handling standards of electrical equipment.
- Modules and power supply have absolute maximum rating. Comply with the specifications to avoid failures or combustion.
- Avoid placing any high temperature objects around the modules, also avoid putting cloth or paper on the modules. It may lead to combustion, burnout, overheat, failure, deformation.
- Modules cannot be used in high-temperature environments, also they must not be subjected to vibration, shock, particles, corrosive or combustive gas. If not followed, it may cause fire, burnouts, bad insulation, failures, overheating and injuries.
- Do not insert or remove power plugs with wet hands to avoid electrical shock.
- While connecting or disconnecting electrical cords avoid being close to any heating equipment. It may lead to melting of the cords cause electrical shock.
- Do not modify the module. This may lead to electrical shock, failure, burnout, changes in module color.
- Do not install modules under direct sunlight or falling water. This may lead to electrical shock, burnouts, overheat, even combustion.
- While installing modules at humid areas, grounding of the power supply must be done.
- Modules cannot be used in combination with other types pf modules, as this may lead to failure.
- Modules can be used at ambient temperatures ranging from -20 °C ~ +50 °C.